

Roof and Wall Panel

WWW.LOROSFORMING.COM

008618914131008

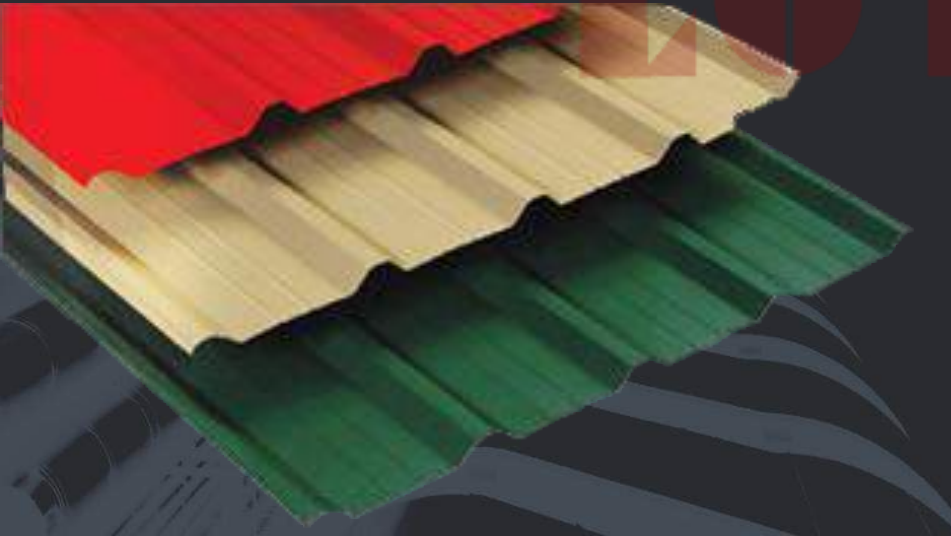

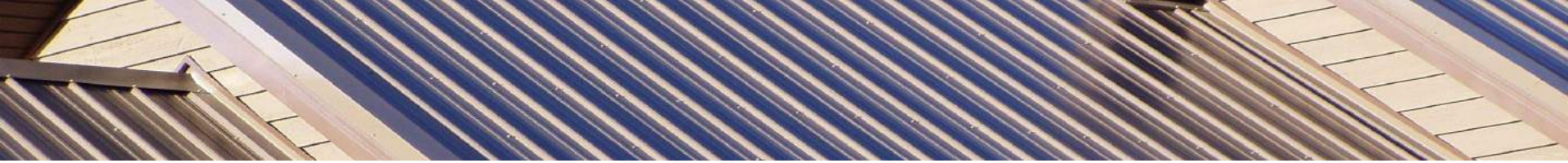

In fact, steel is the most recycled material on the planet, making it an incredibly green building material to work with.

When compared to other metals, steel is also the least expensive. While also being a commodity, steel is often priced at a much lower rate than Aluminum, Zinc or Copper. This makes steel both affordable and available at a greater amount than the other metals in this list.

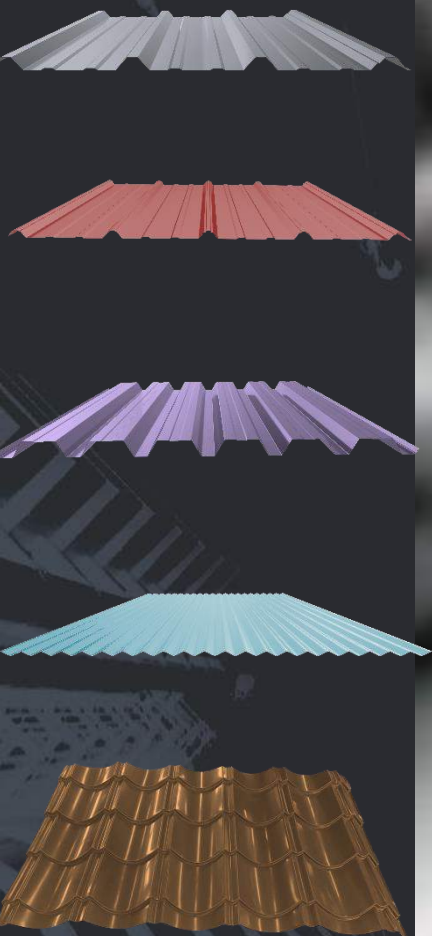

There are (3) primary types of Steel Roofing:

- ✓ Galvanized
- ✓ Galvalume
- ✓ Weathering Steel

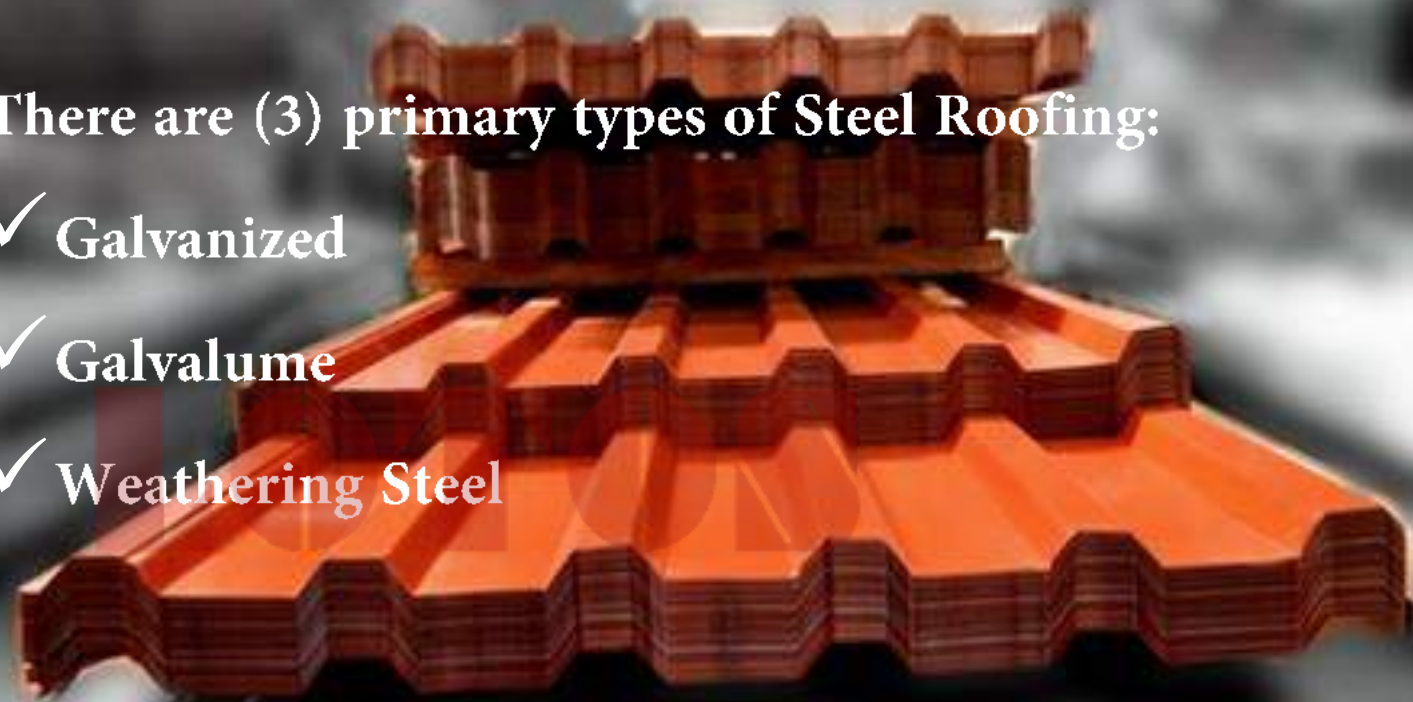



What type of metal roof do you have and what types of metal roofs are available?

NOTES

R-Panel:

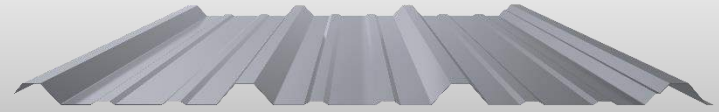

R-Panel metal roofs are the low-maintenance metal roofing option. Their easy installation cuts down on labor, time, and disposal costs, so costs for the entire project are kept low. These roofs are also available in many different colors that look very nice on a roof. These roofing systems are very popular for both residential and commercial roofing systems.

"R" Panel

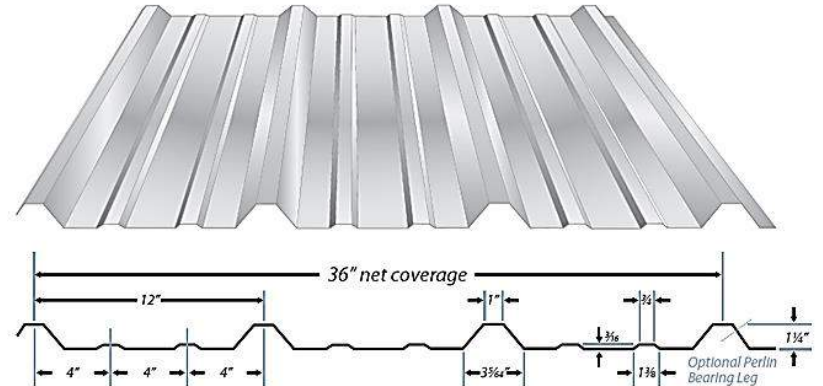

PBR-Panels:

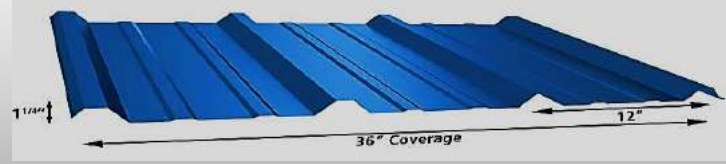

PBR" Panel stands for Purlin Bearing Rib Panel. This panel is far superior to the traditional "R" panel for most roof and siding applications. This panel's secret is an extra lip on the edge that provides superior overlap between panels and seals out the elements.

PBR-Panels include a larger overlap section (purlin bearing leg) between panels that give the metal roofing sheets more strength. R-Panels & PBR Panels are designed primarily for commercial, industrial and steel frame building applications. They both offer versatility and can be used for sidewalls as well as metal roofing panels.

The primary difference between the R-Panel and PBR-Panel is the Purlin-Bearing Leg on the PBR-Panel. This leg provides better support for roof applications. The PBR-Panel is only available in Galvalume and Bone White.

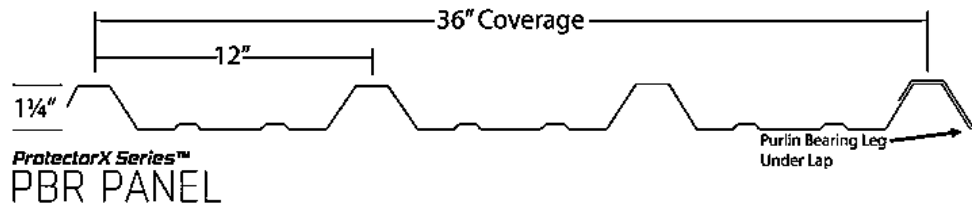

TUFF-RIB PANEL:

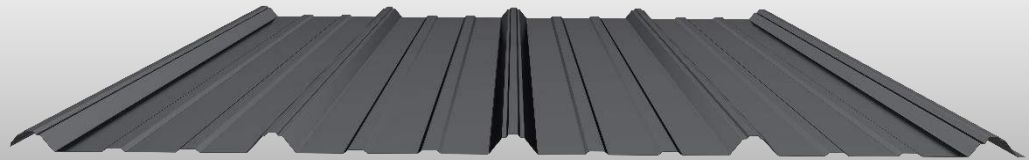

The TUFF-RIB design, our most popular panel, is unmatched in performance and durability. It is used mostly in residential applications but can be used for commercial buildings as well.

One of the most popular and affordable panels, Tuff-Rib is a jack-of-all-trades for metal roofing, siding, and modern accents. Originally designed for traditional and agricultural buildings, Tuff-Rib is built to last and stands up to wind, hail, snow, and rain.

Very similar in looks to Tuff-Rib panel, R-Panels' main differences are in the height of its ribs.

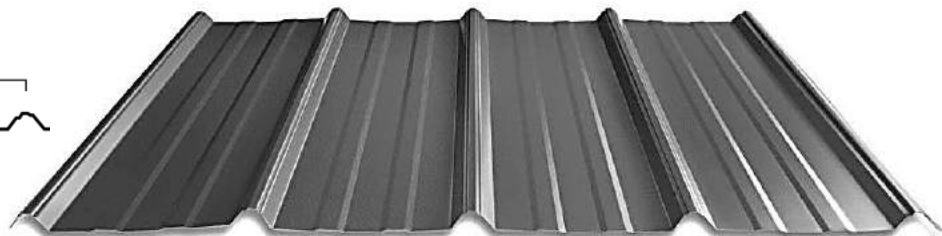
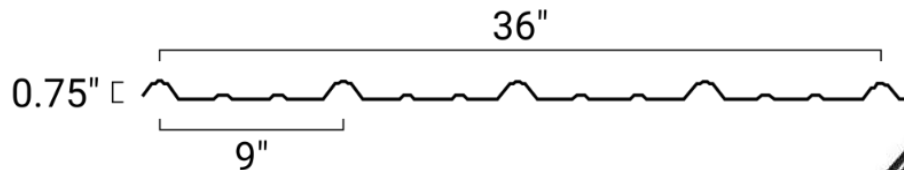

Box Rib PANEL:

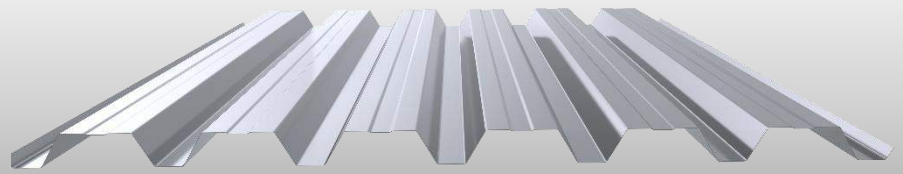

Box Rib Metal Roof and Metal Wall Panels are an exposed fastener metal panel with a 36" net coverage. This panel is ideal for commercial, industrial, retail, mixed-use, civic and even residential applications.

With this long-lasting, durable, and sustainable metal panel, you'll find it also comes in several energy-efficient colors and paint systems. Reversed Box Rib offers a unique, yet flexible design when combined with other building materials.

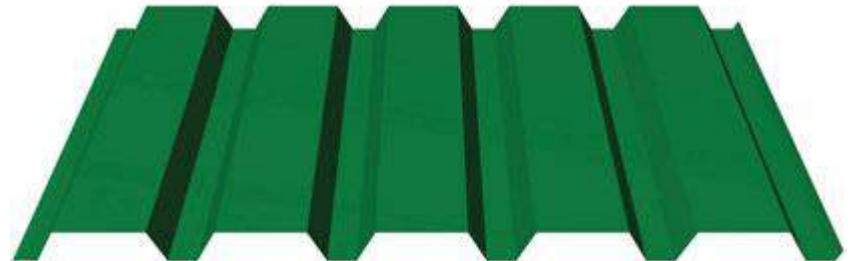
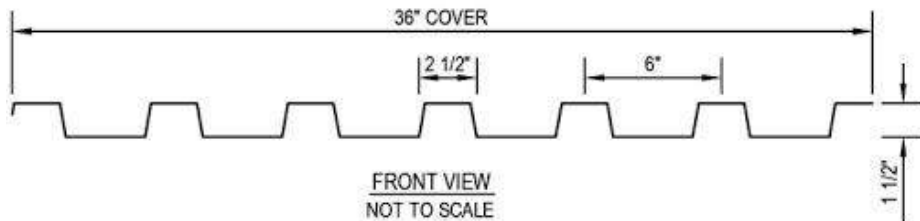

U-Panel:



U-Panel is an exposed fastened wall and roof panel. U-panel offers a lower profile and softer appearance than R-Panel or Multi-Rib. U-Panel is widely utilized as a liner panel or partition wall.

The main difference between R-panels and U-panels is their shape. U-panels have ribs that are the same height across the entire panel, whereas R-panels have ribs of varying heights.

LOTOS

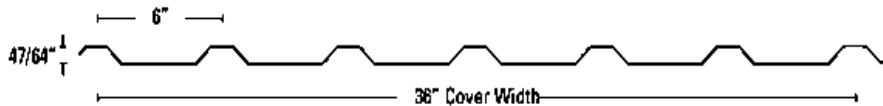
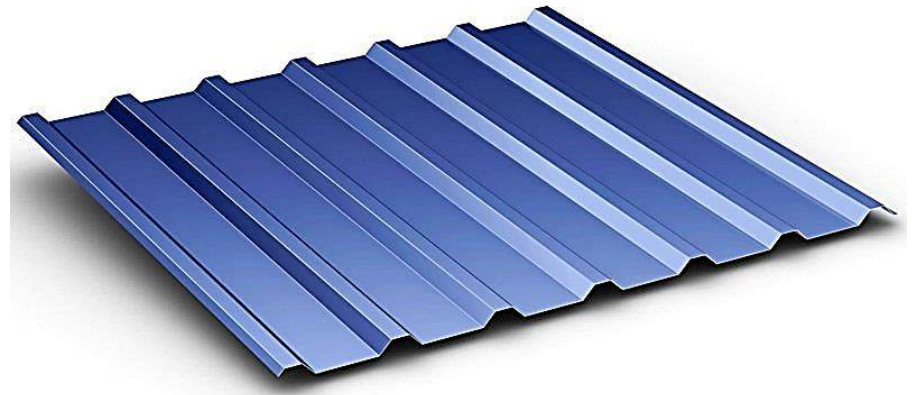

AG metal PANEL:

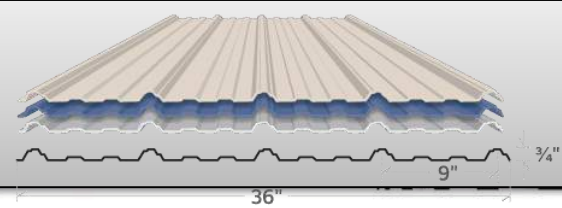

Agricultural metal or AG metal as we call it in the industry is a fine fit for large open un-heated and non-cooled buildings. Unfortunately, all too often we see them used on residential structures. The thermal movement of these structures isn't kind to the very thin ag panel and the exposed fasteners begin to back out after a couple of years resulting in a higher probability of water intrusion.

AG Panel is a durable, weather-resistant roofing solution for agricultural and residential projects. The panels not only provide excellent protection against the elements and increase the life cycle of your roof but they lower the need for maintenance on your roof. AG Panels are a cost-effective, high-performance metal roofing system.

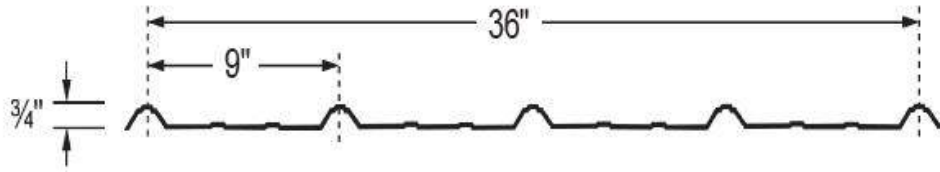

Corrugated PANEL:



This is the classic metal roof, common on many older barns and shacks; the “original” metal roof. Corrugated metal panels are now often galvanized and used on restaurants and retail establishments to create a classic feel. Corrugated metal roofs integrate well with fiberglass skylight panels because they typically have similar patterns and structural designs. Corrugated metal roofs have been around for a long time and they have stood the test of time.

corrugated roof sheets are widely used in many agricultural buildings. This is largely due to the shape that provides enhanced strength ensuring that these roof sheets provide many years of reliable use. In fact, corrugated roof sheets are often used as the base material for other types of a sheet.



STANDING SEAM METAL ROOFS:

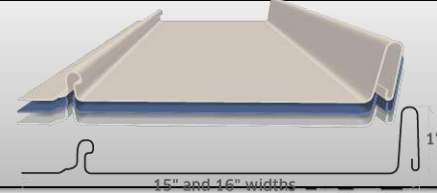

This roofing system provides superior wind uplift protection and resistance to water than other metal roofing systems because of the way the panels interlock. They are extremely tightly constructed and provide a watertight seal that is superior to all other metal roofing systems. It is very difficult for water to work its way into the building thanks to the tight seal, which is obviously a bonus for any roofing system. Many manufacturers apply a sealant to the panels in the factory, which works to maintain the structural integrity in thermal variations.

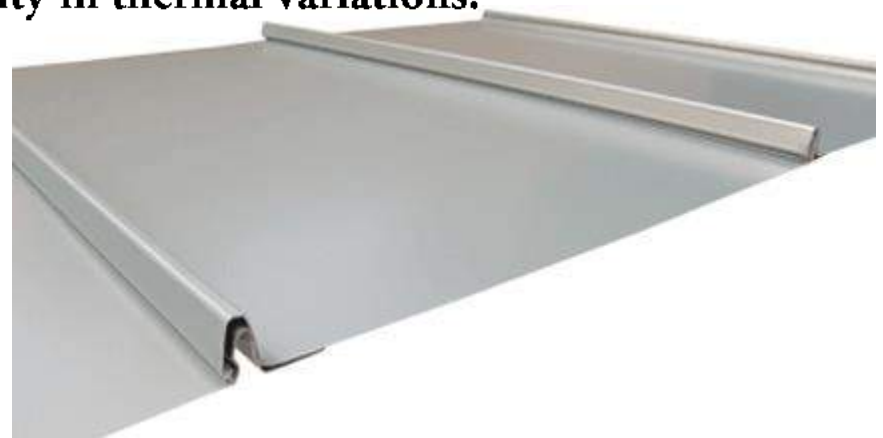

STANDING SEAM METAL ROOFS:

- **COLONIAL SEAM**

The Colonial Seam panel is a clipless, one-piece, positive-locking, standing seam panel that provides a timeless roof appearance. Installation is accomplished by hooking the panel into the previous panel and fastening with mechanical fasteners through pre-punched slots to allow for expansion and contraction. The fasteners are covered by the adjacent panel. The positive locking action makes it virtually impossible for the panels to slide apart.

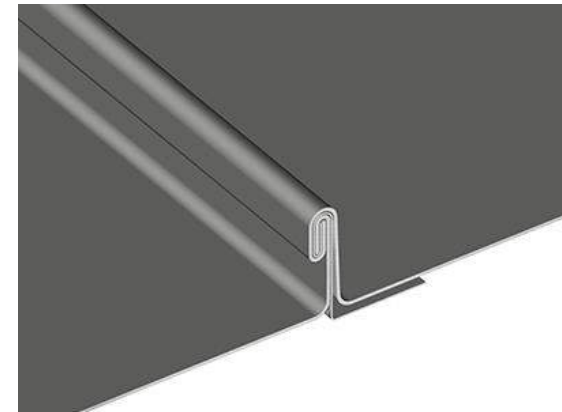
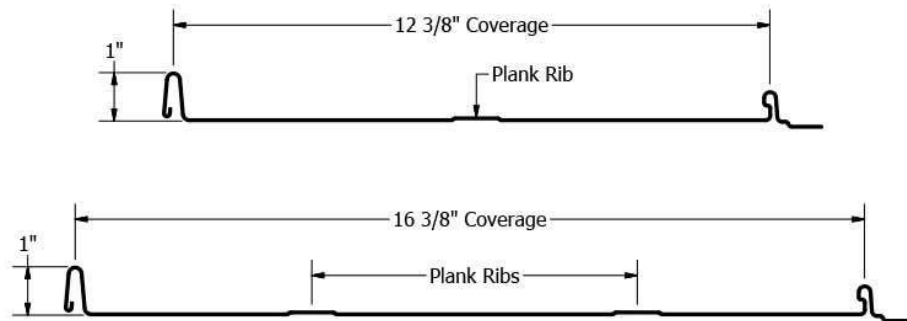

STANDING SEAM METAL ROOFS:

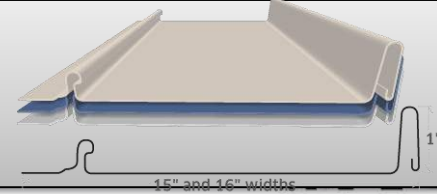

• DUTCH SEAM

Dutch Seam is a continuous standing seam metal roof panel with an integral seam. With the lock and seaman integral part of the panel, there are no seam caps to install. This prevents “blow-off” or “creeping” of the cap or seam. Mechanical field seaming of the panel is not required. Just snap the panel onto the previously installed panel, fasten the clip and the panel is in place. Dutch Seam is a structural metal roof panel and can be fastened directly to purlins or solid substrate. A flat roof can be converted to the correct slope with the simple addition of a lightweight truss system.

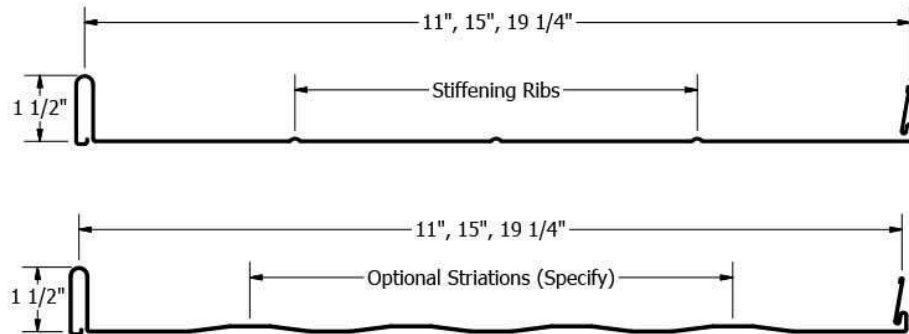

STANDING SEAM METAL ROOFS:

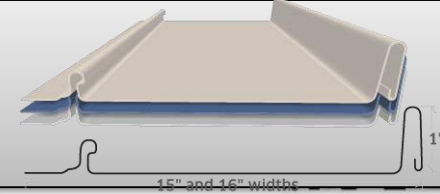

- **Field-Lok panel :**

Field-Lok panel with the high seam is a non-structural mechanically seamed single-locked or double-locked roof panel. The panel system is installed with either an expansion or a fixed clip. It can be curved with or without plank ribs for special accents, as well as over entrances and walkways.

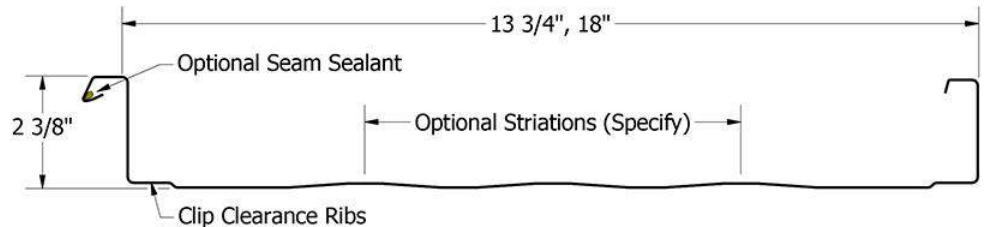
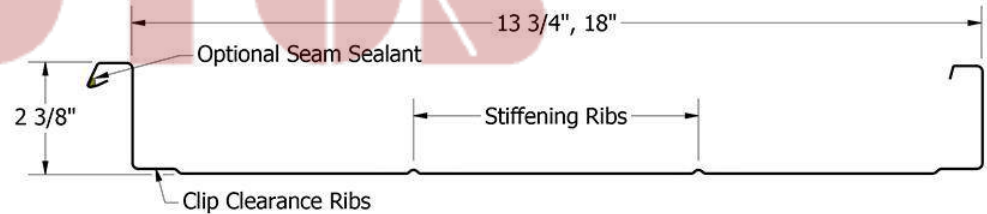
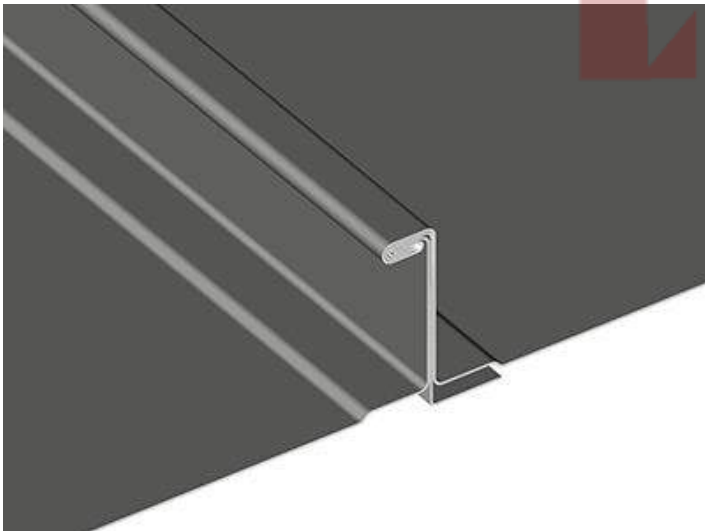

Batten style panel :

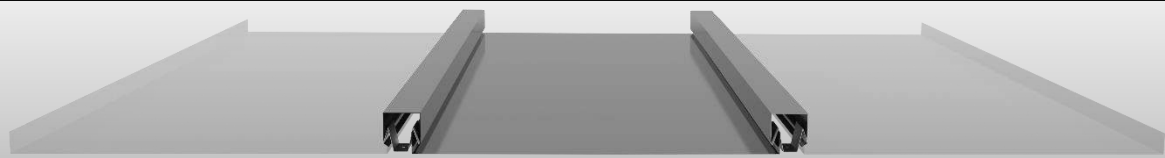

batten style panel with an integral batten and seam. The batten seam and lock are an integral part of the panel, and a vertical “leg” is formed as an extra water barrier. A clip is hooked over the leg; this allows for the expansion of the system. The panels interlock with each other. All clips and fasteners required to install the panel are concealed with the batten of the consecutive panel. Continuous panel lengths eliminate cross seams. Easy one-piece installation lowers on-site labor costs, and there are no extra caps or strips to install. Also, no special equipment is required to zip or seam the panels together.



Batten style panel :

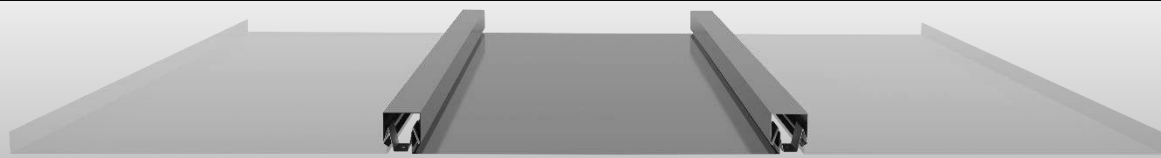

- **Ultra Batten**

Ultra Batten features a bold rib design that mimics a Board & Batten appearance without the need to ever repaint. Available in a flat or striated option.

- **Snap Batten**

Snap Batten is a versatile panel system created for vertical wall applications and seamless transitions between a roofing and siding panel for creating modern aesthetics.

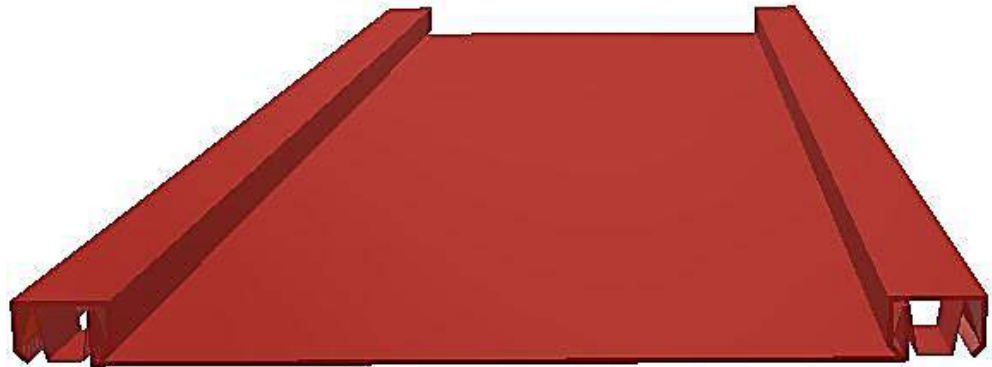
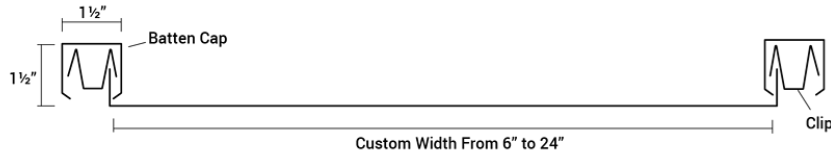

GLAZED TILE:

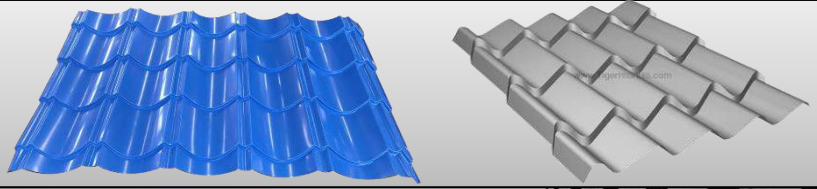

Tile is a metal roof panel with a deep configuration in the form of an “S” or Spanish tile. The panel is installed vertically up the slope of the roof, with exposed fasteners and on a solid substrate. It is lightweight, allowing installation over an existing roof without the need for tear-off and disposal. Typical applications for Tile are commercial and residential roofing. Tile has the look of a clay tile roof without the problems associated with its care.

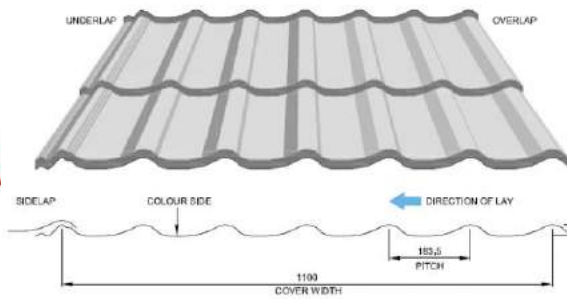
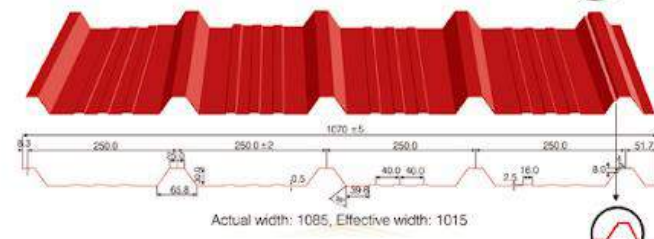
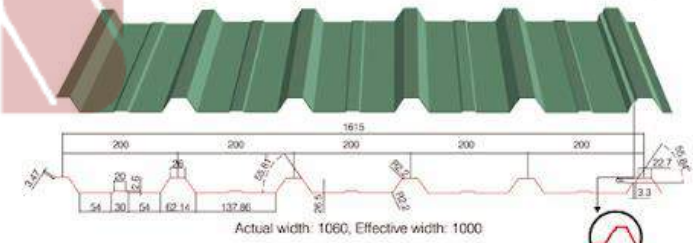
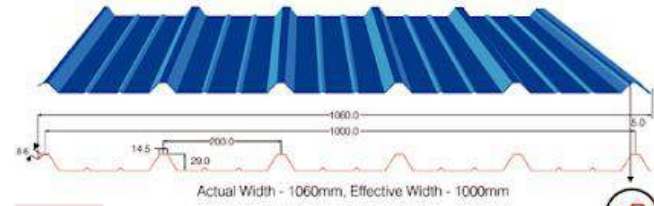

GLAZED TILE:

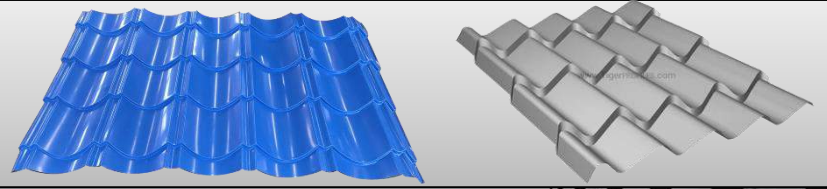

- **Permatile Panel**

metal roofing looks like a tile roof in Florida designed to look like Mediterranean Tile, Permatile offers you the look of this beautiful roof with all of the advantages of metal. Permatile Panel roofing is lightweight & durable. Permatile is quick and easy to install and will hold up well in harsh weather conditions. Permatile also features special infrared reflective coatings the meet Cool Color requirements. Less heat is absorbed into the structure which can help lower energy consumption by up to 40% compared to conventional roofing materials.

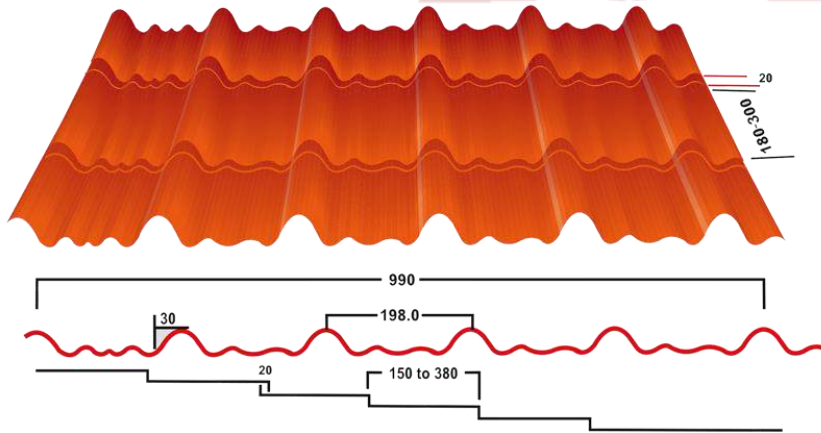

GLAZED TILE:

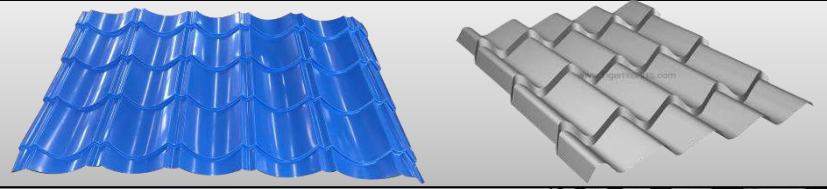

- **Stile Spanish - Mexican Clay Tile Metal Roofing**

Stile is a metal roofing system designed to simulate the durable yet elegant look of Spanish - Mexican clay roofing tiles. Stile comes in full-length panels cut to the foot.

LOTOS

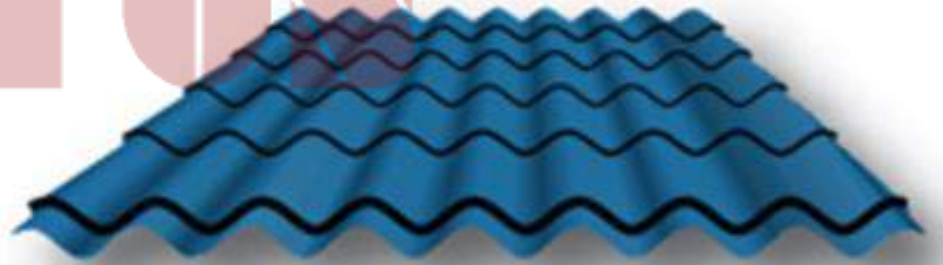
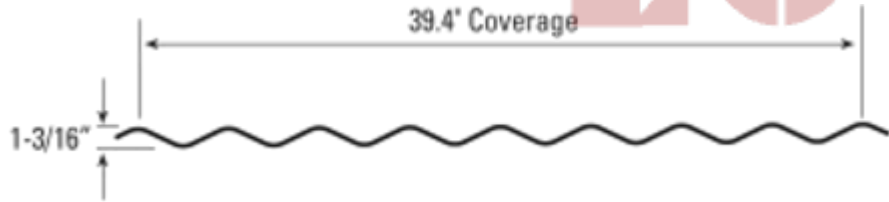

GLAZED TILE:

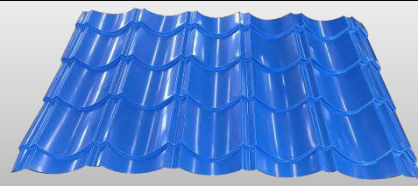

- **Decra Villa Tile Metal Roofing**

Inspired by old-world Italian tile, offers the best features of steel and clay tiles. With realistic tile beauty, longevity, and function, plus the lightweight benefit.

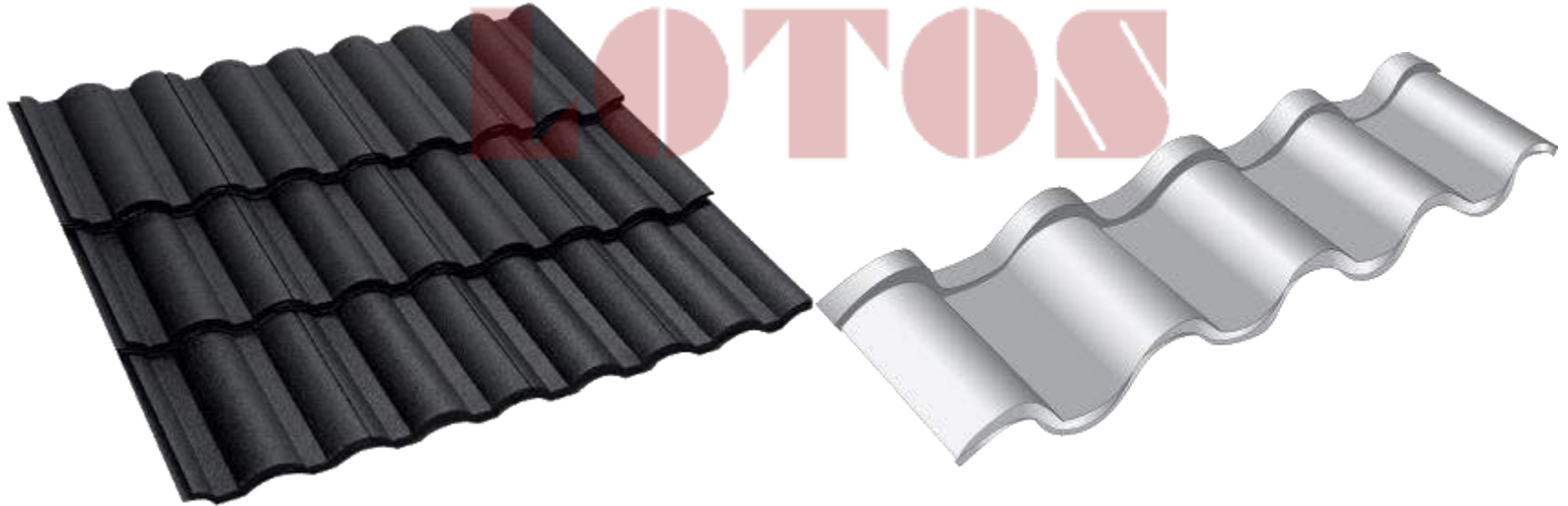

GLAZED TILE:

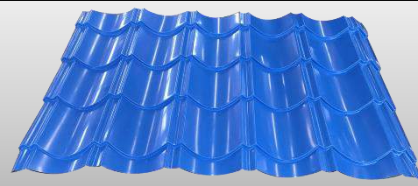

- **GrandeTile**

GrandeTile offers the timeless look of tile, with greatly reduced weight and the exceptional durability of quality aluminum shingle panels. Perfect for residential properties, light commercial, and mansard roofs, this outstanding roofing profile adds beauty, charm, and a lifetime of protection.

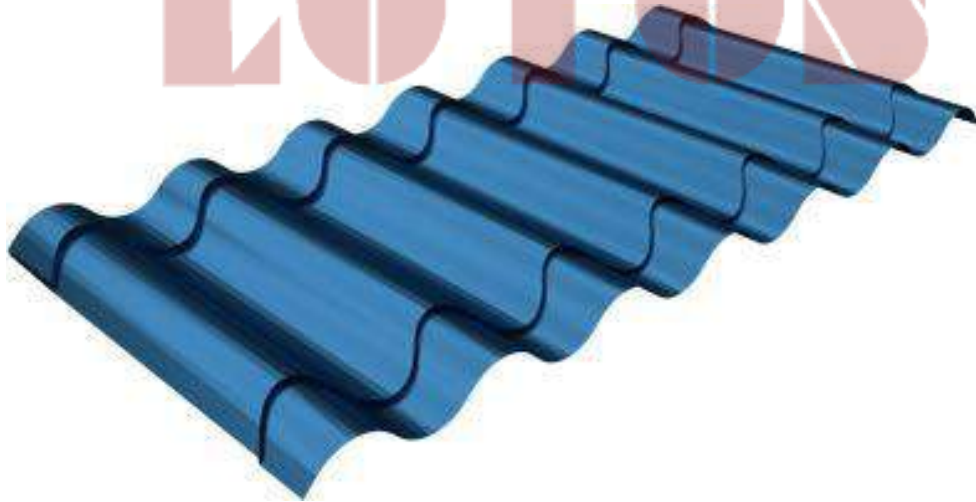

GLAZED TILE:

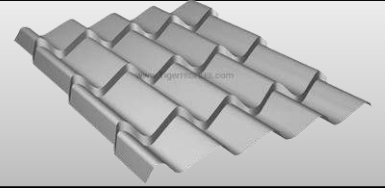
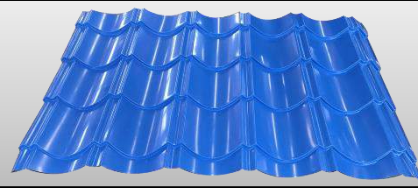

- **Alexxa European Clay Tile Metal Roofing**

Alexxa European Tile is a press formed metal roofing panel, the design of this panel creates a beautiful scallop tile appearance.



GLAZED TILE:

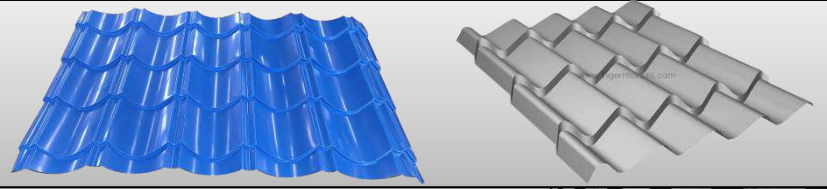

- **ScanRoof Tile**

ScanRoof a scalloped tile with a Northern European flair is an easy-to-install metal roof panel. The panels are structural, practical and unique, efficient for any project. ScanRoof is the ideal roof system to stand up against Mother Nature's storms, typhoons, hurricanes, damaging winds, and driving rains. The panel is installed horizontally, from eave to ridge.

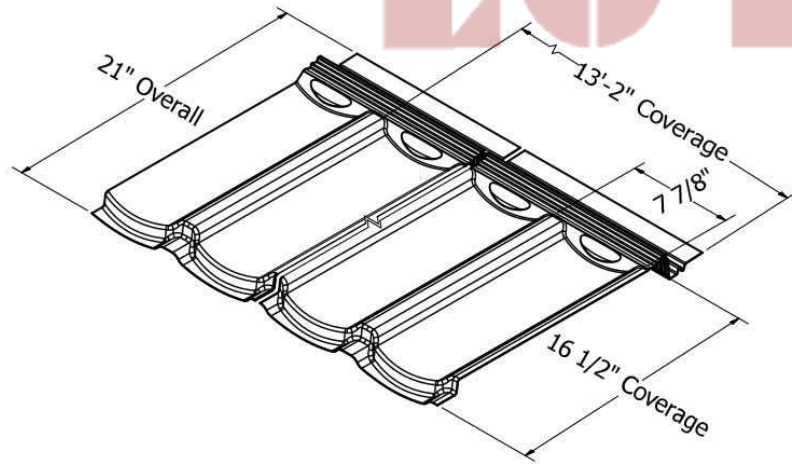

GLAZED TILE:

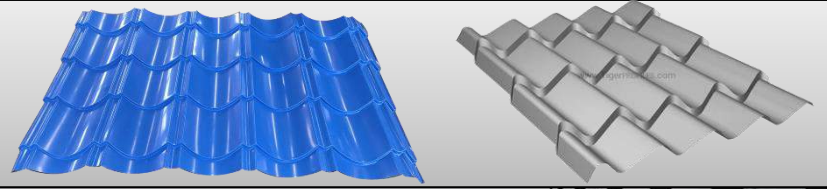

- **Techo Tile**

Techo Tile is a metal roof panel with a deep configuration in the form of an “S” or Spanish tile. The panel is installed vertically up the slope of the roof, with exposed fasteners and on a solid substrate. It is lightweight, allowing installation over an existing roof without the need for tear-off and disposal.

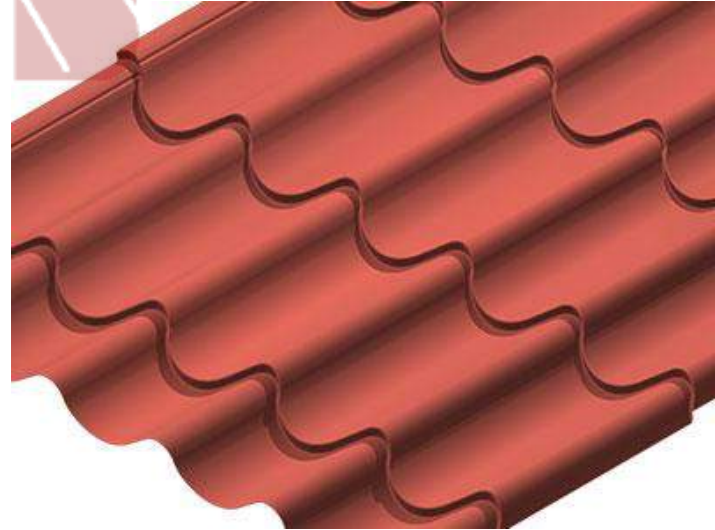
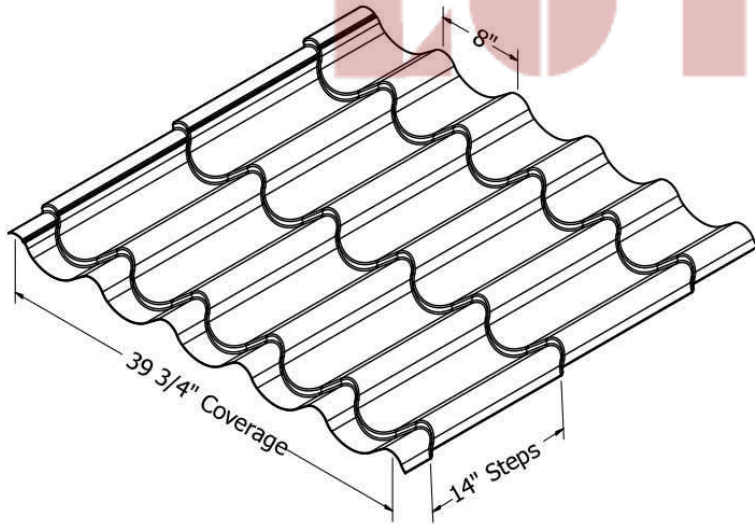

Belvedere Penum Wall panels:

Belvedere Penum Wall panels can be installed either on a solid substrate or open framing. Belvedere Penum Wall is a structural wall panel that offers design freedom for all types of buildings. Shadow lines create architectural detail. The panel can be installed either on a solid substrate or spaced framing. It is through-fastened using color-matched, exposed fasteners.

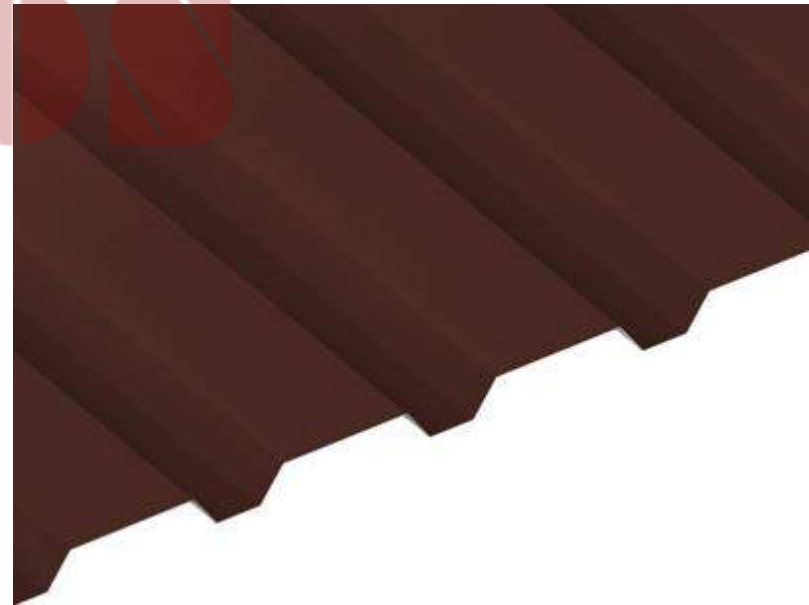
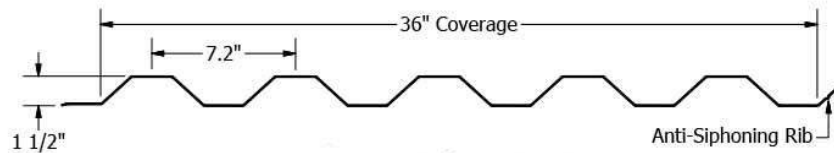

Grand V panels / Grand C panels:

Grand V panels provide a unique solution to the metal roofing and metal siding needs of today. Panels are designed for use over solid substrates or open framing with support members spaced a maximum of 24 inches on center. Typical applications include walls, fascias, mansards, equipment screens, and some limited roofing.

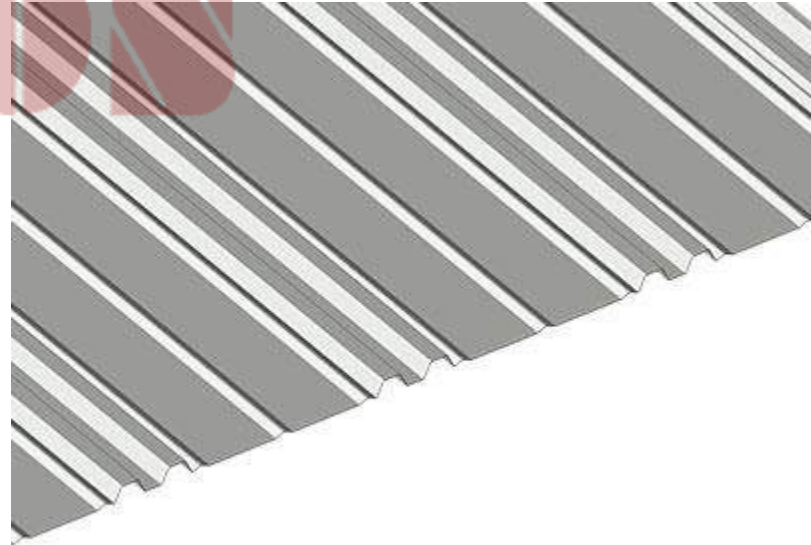
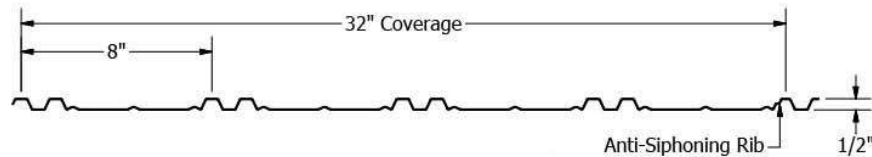

Grand V panels / Grand C panels:

Grand V panels provide a unique solution to the metal roofing and metal siding needs of today. Panels are designed for use over solid substrates or open framing with support members spaced a maximum of 24 inches on center. Typical applications include walls, fascias, mansards, equipment screens, and some limited roofing.

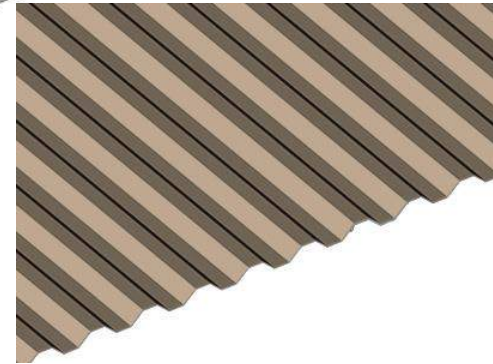
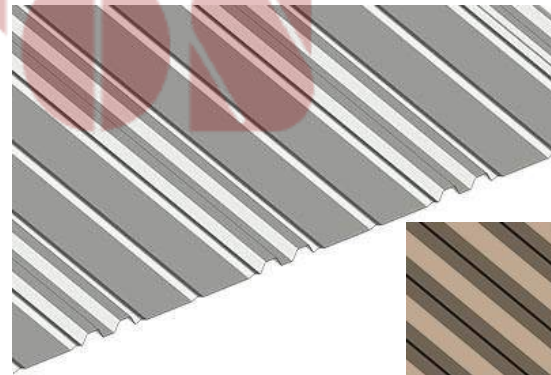
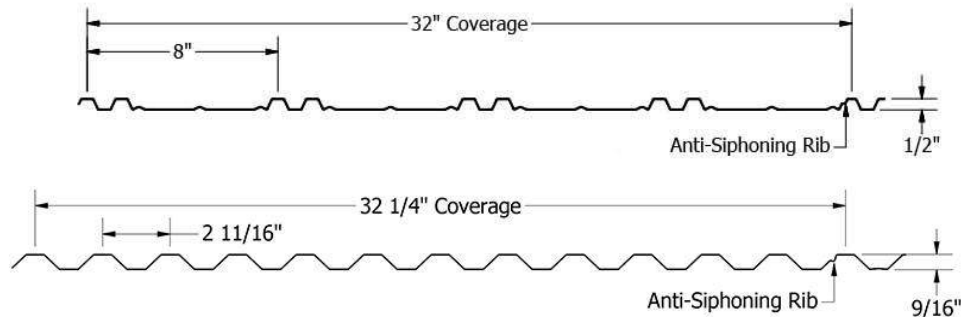

SPAN WALL PANEL:

Span Wall is a structural wall panel that offers design freedom for all types of buildings. The panel can be installed horizontally or vertically on a solid substrate or spaced framing. The texture is either smooth or embossed, depending on the gauge of the material.

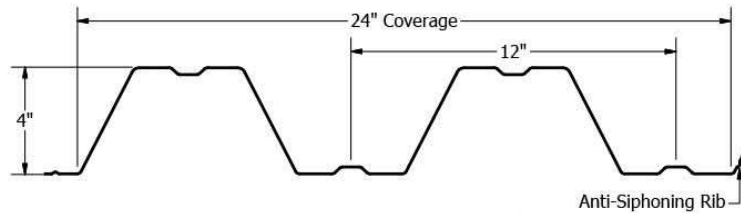

LOTOS

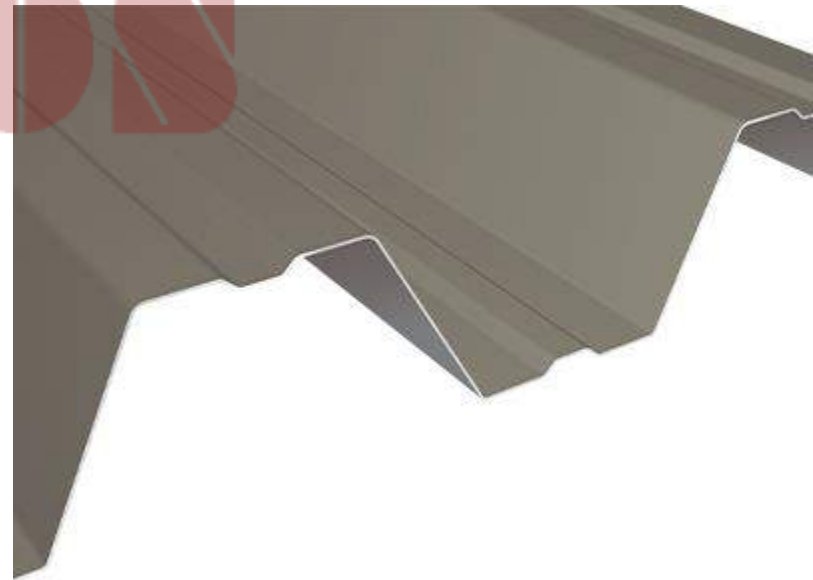

Roof and Wall Panel

WWW.LOROSFORMING.COM

008618914131008

